

SUGGESTED PCB LAYOUT
(TOP VIEW)

ELECTRICAL SPECIFICATIONS @ 25°C +/- 5°C unless otherwise noted:

Insertion Loss: 1-100MHZ -1.0dB MAX

Return Loss: 1-30MHZ -16.0dB MIN
30-60MHZ -14.0dB MIN
60-80MHZ -10.0dB MIN

Cross Talk: 1-30MHZ -40.0dB MIN
30-60MHZ -35.0dB MIN
60-80MHZ -30.0dB MIN

CMR: 1-100MHZ -35.0dB MIN

Hi-Pot: 1500v AC 6S 1mA

OCL:350uH MIN @ 100KHZ 100mV 8mA DC

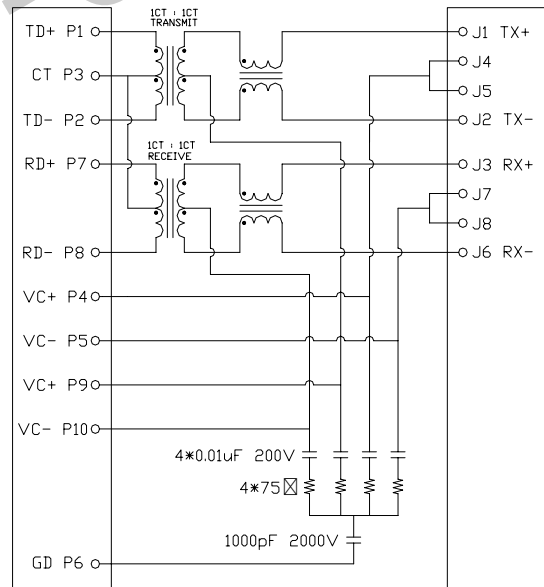

Contacts: 0.35mm thick phos bronze plated with 6u' gold in contact area

Turn Ratio: 1CT:1CT+/-3%

Operating temperature range:0°C to +70°C

Housing Material: PBT Black

HDC 有限公司

UNIT: mm

.XX +/-0.25 .XXX +/-0.13

Approved By : Herman Au

10/100BASE
1X1Tab-Down RJ45

P/N: GRJJ-H7165

REV.
A

Drafted by CZ Lin

Sheet 1 of 1